

PULSAR 2 v 2.15



PULSAR 2 is a fast, microcontroller-based charger suitable for use with various types of batteries. Special design of hardware and software makes it possible to charge batteries with high currents without risk of damage and in some cases even improving their durability. During charging process all important parameters are displayed on LCD and transmitted via serial port (RS232) to a desktop computer. Additional software allows visualization of changes in voltage, current, voltage time derivative and temperature during whole charging process which allows user to determine precisely status of batteries and decide whether they need conditioning or not. A data communication between **Pulsar 2** and **Pulsar-EQUAL** Equalizer (Balancer) is possible and increases the safety of working with Li-Xx packs.

Technical specification	
Battery types supported	Ni-Cd, Ni-MH, Pb-bat, RAM, Li-Ion, Li-Pol, Li-Ta, Li-Ph (<i>Li-Ion FePO4</i>)
Supply voltage	10 – 16V DC (car battery min 30Ah (70Ah recommended) or power supply 14V/30A)
Low voltage alarm level (alarm)	min 10 – 11,5V adjustable in <i>Setup</i> max 16V
Charging voltage	0.5 - 60V from 1 up to 32 Ni-Cd cells
Charging current	200mA – 9,9A (250W)
Discharging current	200mA – 9,9A (250W) with energy return 200mA – 9,9A (35W) with heat dissipation
Temperature measurement	0 - 99°C with 0.1°C accuracy
Voltage measurement	0,1 – 60V
Current measurement	0,1 – 11A
Time measurement	up to 14 hours
Max voltage on supply battery	Revers - On 15,3V

Starting-up Pulsar Charger

PULSAR charger is designed to work with car battery, but it is possible to use it with DC power supply with output voltage 12-14V and output current at least 5A (30A recommended).

Red cable +12V
Blue cable -12V, ground

There are three connectors on the left side of the device:

- temperature sensor connector (and **Pulsar Equal** communication socket)
- fan connector (max. 1.2A) – for cooling battery pack
- serial port connector (RS232 – DB9) – to connect to PC (9 pin)

After turning the charger on you can enter **Setup** by pressing ‘**M**’ key and switch on/off sound signal and adjust minimum input voltage level, which protects supply battery from discharging - if supply voltage fall below desired level charging is stopped and alarm turns on (protection against excessive discharge of car battery).

Pressing **Start** (‘**E**’ key) takes you to the main menu.

-	P	U	L	S	A	R	-			V	2	.	1	5	
S	t	a	r	t						S	e	t	u	p	

Mode	Keys	Action
Start	E	Main menu <i>Mem 1-8; Format, Test</i>
Setup	M	Global parameters: 1. Bip <i>ON/OFF</i> – sound signal (+,-); E 2. T max <i>On/Off</i> – termic protection (+,-); E 3. T on < from 30 to 45°C – start with T<Ton (+,-); E 4. T off < from 50 to 65°C – stop with T>Toff (+,-); E 5. Voff from 10V to 11,5V - min supply voltage (+,-); E

(+,-); E – choose a parameter with ‘+’ or ‘-’ keys and confirm selection with ‘E’ key.
Adjusted parameter is blinking on LCD panel.

- Tmax on – Start analyzing temperature Ton and Toff.
- Ton – if packet temperature exceeds set up Ton temperature, process will start only after cell temperature fall to Ton temperature.
- Toff – exceeding set up Toff temperature, will stop the process and start alarm

Current adjust and limiter function

By shortly pressing **E** key process’s current can be changed. If it is the complex process (Dis/Ch. discharging/charging) different currents can be set.

D	i	s	c	h	.			8	,	0	A			R	A
-	-	,	-	A	h			N	i	-	C	d			8

In current adjust mode it is possible to set the maximal package capacity (0,1 – 12 Ah). When it is reached the process will be terminated – *limiter*. After pressing **M** key, +, - keys are used to set the value and **E** key to accept (--,-Ah – function disabled).

Process Initialization

Right after connecting packet to charger, connection test will start. After that charger estimate number of cells in the packet. When battery is charged or excessively discharged number of cells should be corrected (+,-). Confirmation with **E** key will start appropriate action, depending on a set mode.

D	i	s	c	h	.			9	,	0	V			R	A
-	-	,	-	A	h			0	7		N	i	-	C	d

During correction of number of cells, we can set maximal capacity of packet (0.1 – 12.0 Ah) after reaching it process will be terminate. After pressing **M** key we will be able to set capacity by pressing + or – and confirm that with **E** key (--,-Ah, means that function is turned off).

Process end

Process end is signaled by flashing of the displayed data, display's backlight blinking and periodic sound signal. After 30 seconds a sound signal is replaced by "silent knocking". Display shows the last values measured during the process.

A new process on the same accu pack can be started after reconnecting of the accu pack!

Main menu (battery is disconnected)

Main menu consist of 10 windows.

- M 1-8 processes memory, formatting/regeneration and battery test

Memory of the processes M1-8

Memory number – a digit in the right down corner on display.

There are 8 memories. Each can save:

Process parameters

Main parameter is charging/discharging current. at the complex processes (discharging/charging, charging/discharging) there is a possibility to set up different value of charging/discharging current.

Work mode

discharging – *Disch.*, charging – *Charge*,

discharging /charging – *Dis/Ch.*, charging/discharging – *Ch/Dis*.

Cell Type

Ni-Cd, Ni-MH, Pb-bat, RAM, Li-Ion, Li-Pol, Li-Ta, Li-Ph

Info window (battery is disconnected)

To open information window press the **M** key.

V	b	=	1	2	,	5	V	T	c	=	2	3	,	7
	M	e	m					2	,	1	3	1	A	h

Vb=12,5V - supply voltage
 Tc=23,7 - battery pack temperature (--,- - sensor not connected)
 Mem - saved data from 8 previous processes
 2,131Ah - energy measure from last process

To read data from 8 previous press the **E** key.

M	8					1	6	N	i	-	C	d	
	M	e	n	u		-	2	,	1	3	1	A	h

M8 - save no. 8
 16 - amount of cells
 Ni-Cd - cell type
 Menu - return to main menu (E)
 -2,131Ah - energy, mark (-) means discharge

Info.	Keys	Function
Battery disconnected	+ or –	change program
	M	info window
Info window	M	return to main menu
	E	saved data from 8 previous processes
Saved data	+ or –	change save no.
	E	return to main menu
	M	return to info window

Discharging (0,2 – 9,9A, Revers, Auto)

D	i	s	c	h	.		8	,	0	A			R	A
-	-	,	-	A	h		N	i	-	C	d			8

R - Reverse mode is on
A - Auto mode is on

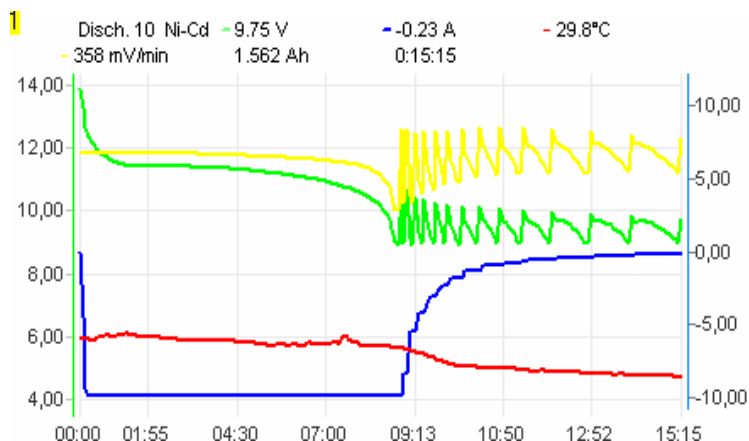

Discharging lasts until battery voltage reaches threshold voltage for given cell type. In *Auto* mode current is decreased by ¼ each time the threshold voltage is reached. Discharging process ends when discharging current is less than 200mA. *Reverse* mode – energy from discharging battery is transferred back to the supply accumulator.

D	0	8	-	8	,	0	A			7	,	2	V	↓	E
0	0	:	1	2	:	3	4		1	,	9	1	5	A	h

every 5 seconds – second line

V	b	=	1	3	,	5	V			4	4	,	7	°	C
---	---	---	---	---	---	---	---	--	--	---	---	---	---	---	---

A bold 'A' after a value of current indicates that charger has limited current due to maximum power.

D 08 - discharging; 8 cells
-8,0A - actual, measured current
7,2V - actual, measured voltage
↓ - marker of decreasing voltage
E - marker of current limit (blinking)
00:12:34 - time elapsed from start of the process
1,915Ah - energy returned
Vb=13,5V - supply voltage
44,7°C - battery temperature

Disch.	Keys	Function
Battery disconnected	+ or -	change program
	E	current set up (+, -); E
	E (1 s)	remaining parameters set up 1. Revers <i>On/Off</i> – energy return (+, -); E 2. Auto <i>On/Off</i> – decreasing voltage (+, -); E
	M (1 s)	change work mode and cell type
Battery connected	M	info window
	E (1 s)	stop discharging
	M	LCD light

Important Notices

- Maximal duration of this process – 14 hours.
- You must NOT use *Reverse* function if you are using external DC power supply unit.
- While working in reverse mode (reverse – on) discharging current will be limited if voltage on supply battery exceeds 15,3V (protection from overcharging)

Charging Ni-Cd & Ni-MH (0,2 – 9,9A, Inflex, Reflex, Delta peak)

C	h	A	r	g	e		8	,	0	A		i	r	d
-	-	,	-	A	h		N	i	-	C	d			7

- i - Inflex mode is ON
- r - Reflex mode is ON
- d - Delta – Δ low (D – Δ high) function is ON

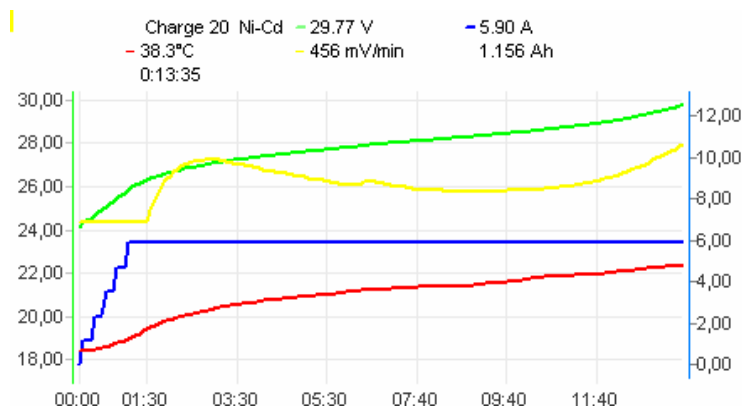

Charging ends when voltage drop ($-\Delta v$) or inflex point is detected.

The *Inflex* mode allows finishing charging process before unnecessary heating of charged battery (inflex point marker – vertical line on the current graph).

The *Reflex* mode makes it possible to recharge batteries and avoid *memory effect* (charging with short compensatory discharging pulse)

C	0	8		8	,	0	A		1	2	,	9	V	↑	i
0	0	:	1	6	:	0	0		2	,	3	2	6	A	h

every 5 seconds – second line

V	b	=	1	2	,	1	V		4	0	,	0	°	C
---	---	---	---	---	---	---	---	--	---	---	---	---	---	---

A bold 'A' after a value of current indicates that charger has limited current due to maximum power.

- C 08 - charging; 8 cells
- 8,0A - actual, measured current
- 12,9V - actual, measured voltage
- ↑ - marker of increasing voltage
- i - marker of inflex point detection (blinking)
- S - marker of slow start mode (blinking)
- 00:16:00 - time elapsed from start of the process
- 2,326Ah - energy taken
- Vb=12,1V - supply voltage
- 40,0°C - battery temperature

Charge	Keys	Function
Battery disconnected	+ or –	change program
	E	current set up (+, –); E
	E (1 s)	remaining parameters set up 1. Inflex <i>On/Off</i> – stop at inflexion point (+, –); E 2. Reflex <i>On/Off</i> – equalizing impulse (+, –); E 3. Delta <i>low / high</i> – value $-\Delta V$ (+, –); E
	M (1 s)	change work mode and cell type
	+ and –	*forced start
	M	info window
Battery connected	E (1 s)	stop charging
	+	shorten slowly start (if pointer S blinks)
	M	LCD light

Important Notices

- Maximal duration of this process – 14 hours.
- *) Forced start – charging diode protected battery (RC transmitter). Reflex function will be automatically disabled! Charging currents > 1,2 A should not be used.
- Delta *low* – 7mV Ni-Cd, 3mV Ni-MH; Delta *high* - 10mV Ni-Cd, 5mV Ni-MH
- Delta *high* – rather for currents lower than 1C for Ni-Cd and 0,5C for Ni-MH
- *Inflex* – switched on for currents higher than 1C and from 4 cells

Charging PB-bat, RAM, Li-Ion, Li-Pol, Li-Ta, Li-Ph. (0,2 – 9,9A, Fast, Reflex, V end)

C	H	A	r	g	e		6	,	0	A		F	r	v
-	-	,	-	A	h		L	i	-	P	o	l		6

- F - Fast mode ON
- r - Reflex mode ON
- v - correction of threshold voltage is ON (it can be reduced by 200mV with 10mV step)

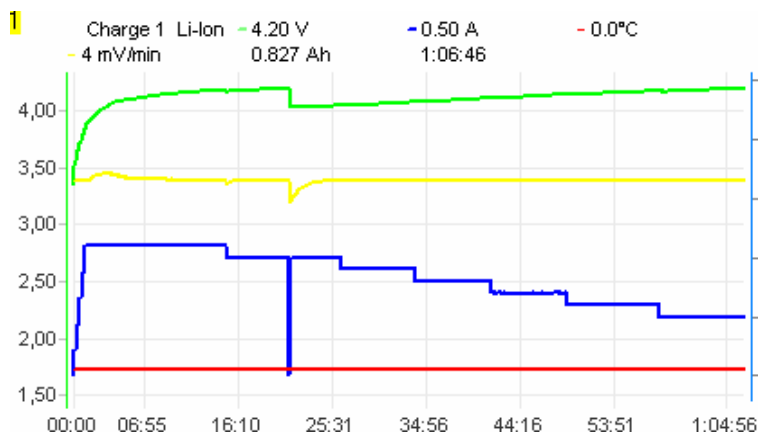

Charging ends when threshold voltage is detected and simultaneously charging current is decreased. When *Fast* mode is on charging current is controlled with pulses, which makes it possible to reduce charging time more than two times. Current limitation can occur when voltage overstep maximal value for given cell types. We recommend the ***Pulsar EQUAL*** Equalizer from ELPROG.

C	0	2		1	,	0	A		8	,	2	V		E
0	1	:	2	:	2	5		1	,	2	9	8	A	h

every 5 seconds – second line

V	b	=	1	2	,	5	V		2	3	,	7	°	C
---	---	---	---	---	---	---	---	--	---	---	---	---	---	---

A bold 'A' after a value of current indicates that charger has limited current due to maximum power.

- C 02 - charging; 2 cells
- 1,0A - actual, measured current
- 8,2V - actual, measured voltage
- E - marker of current limitation (blinking)
- S - marker of the *slow start* mode (blinking)
- 01:23:25 - time elapsed from start of the process
- 1,298Ah - energy taken
- Vb=12,5V - supply voltage
- 23,7°C - battery temperature

Charge	Keys	Function
Battery disconnected	+ or -	change program
	E	current set up (+, -); E
	E (1 s)	remaining parameters set up 1. Fast <i>On/Off</i> – fast charging mode (+, -); E 2. Reflex <i>On/Off</i> – equalizing impulse (+, -); E 3. V end – correction of threshold voltage (+, -); E
	M (1 s)	change work mode and cell type
	+ and -	forced start
Battery connected	M	info window
	E (1 s)	stop charging
	+	shorten slowly start (if pointer S blinks)
	M	LCD light

Important Notices

- Maximal duration of this process – 14 hours.
- Reduction of threshold voltage *V end* under standard value (voltage for single cell) will display “v” mark.
- Switching on *Reflex* mode increases constant current charging phase time (that could shorten overall charging time), reduces sudden increase of internal resistance effect, cell pressure and temperature, allows using higher charging currents.
- Do not use Fast mode to charge battery with balancers limiting charging voltage. It is allowed to use balancers leveling cells voltage during charging.

Formatting / Conditioning (0,2 – 4A, cell type, Regen., Cycle)

F	O	r	m	a	t		1	,	8	A		*	8	C
-	-	,	-	A	h		N	i	-	C	d			

*8 - no. of cycles – 8
 C - conditioning is ON

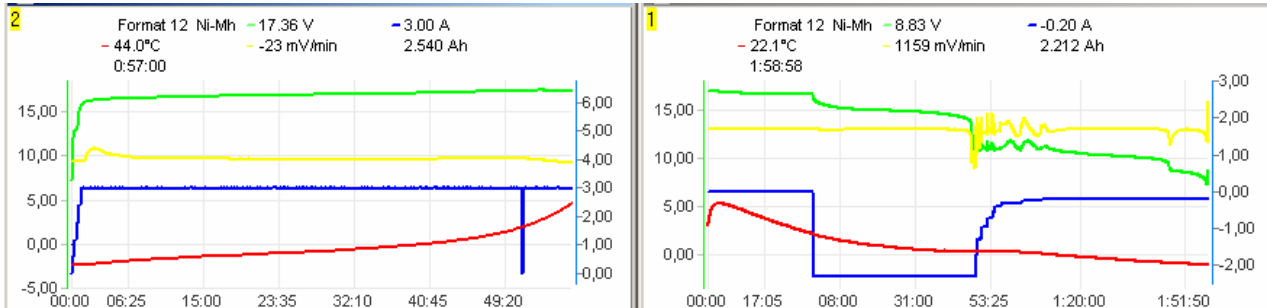

Formatting a battery means to perform demanded number (1 to 8) of discharging-charging cycles. Discharging is performed in *Auto* mode until threshold voltage is reached, which depends of cell type. Reconditioning a battery – special formatting mode which allows to repair the battery.

F	0	8		1	,	8	A		1	2	,	8	V		i
0	1	:	1	0	:	0	4		2	,	0	8	2	A	h
every 5 seconds – second line															
V	b	=	1	2	,	5	V		3	6	,	6	°	C	4

A bold 'A' after a value of current indicates that charger has limited current due to maximum power.

- F 08 - formatting; 8 cells
- 1,8A - actual, measured charging or discharging current
- 12,8V - actual, measured voltage
- 01:10:04 - time elapsed from start of the process
- 2,082Ah - energy taken or returned
- 4 - no. of charging before process finish
- Vb=12,5V - supply voltage
- 36,6°C - battery temperature

Format	Keys	Function
Battery disconnected	+ or –	change program
	E	current set up (+, -); E
	E (1 s)	remaining parameters set up 1. cell type (+, -); M or E 2. Regen. <i>On/Off</i> - cell regeneration (+, -); M or E 3. Cycle <i>1-8</i> – number of cycles (+, -); E
	M (1 s)	change work mode and cell type
	M	info window
Battery connected	E (1 s)	stop charging
	+ or –	shorten slowly start
	M	LCD light

Important Notices

- Maximal duration of this process (1 cycle) – 2*14 hours.

Test (0,2 – 4A max 35W, cell type)

T	e	s	t					1	,	0	A			
								N	i	-	C	d		

Battery test is done for each cell type at three stages.

- precise voltage measurement
- voltage measurement loaded with set circuit for 10 s.
- internal resistance measurement of the packet

Right after battery is connected exact voltage and no. of cells will be shown.

Next step is to correct no. of cells and start battery test by pressing **E** key (Start).

T	e	s	t					1	2	,	9	3	3	V		
S	t	a	r	t				1	0		N	i	-	C	d	

10 s battery loading with set circuit will start.

T	e	s	t					1	,	0	A			
	0	,	0	0	0	Ω		1	2	,	5	5	8	V

For next 5 s impulse loading. After that battery's internal resistance will be calculated.

T	e	s	t					1	,	0	A			
	0	,	0	3	2	Ω		1	2	,	6	3	7	V

To see internal resistance and voltage of the battery counted for each cell press **M** key.

T	e	s	t					1	,	0	A			
	0	,	0	0	3	Ω		1	,	2	6	3	V	C

C - marker inform that value is counted for single cell.

Again pressing **E** key will repeat the test.

Battery's internal resistance measurement method is different than method used by cell producers. This could cause variance in received results. The resistance of wires connected to battery is not measured neither (variety types of cables and connections exclude that possibility), that's way measurement of single cell could be affected with big error.

Internal resistance measurement should be regarded as a comparative measurement of multiple packets. Measurement should be taken by the same cable.

Alarm messages (sound alarm)

- Tc=50,0 - *Toff* („Tc=" blinking) temperature is overstepped
- Vb=16,0V high - supply voltage is too high („high" is blinking)
- Vb=10,5V low - supply voltage is too low („low" is blinking)
- VC=high - maximal voltage for single cell is overstepped („VC=" is blinking)

In those cases process will be stopped. Pressing any key will stop the alarm.

Cells Characteristic parameters

	Ni-Cd	Ni-MH	Pb-bat	RAM	Li-Ion	Li-Pol	Li-Ta	Li-Ph
Name	nickel-cadmium	nickel-metal-hydride	lead-acid	alkaline	lithium-ion	lithium polymer	lithium tadiran	lithium phosphate
Voltage	1,2V	1,2V	2V	1,5V	3,6V	3,7V	3,0V	3,3V
Discharging voltage	0,9V	1,0V	1,8V	1,0V	3,0V	3,3V	2,4V	2,8V
Max. charging voltage	1,85V	1,85V	2,45V*	1,65V*	4,1V*	4,2V*	3,45V*	3,65V*
Charging current	0,2 – 2C max 4C	0,2 – 1C max 2C	0,1 – 0,4C	0,2 – 1C	0,1 – 1C	0,1 – 1C	0,1 – 0,4C	1-4C
no. of cells	1 - 32	1 - 32	1 - 18	1 - 26	1 - 12	1 - 12	1 - 12	1 - 14

*- it can be reduced by 200mV with 10mV step

Where C is capacity of battery (1C for 2400mAh capacity is equal to 2,4A current)

Values shown in the table are characteristic for particular types of cells, but it is recommended to check which parameters are admissible by producer of the cell. Ex. to charge propulsive Ni-MH cells with 2C circuit battery needs to be cooled. Using *inflex* mode highly decrease heat diffusion at late charging process. Generally propulsive cells (which small internal resistance) could be charged with higher circuit. Cells which are used with transmitter/receiver in RC devices should be charged with maximum 1,2A circuit. That restriction come off thickness of the wires used with that packets and construction of battery containers.

Ni-Cd, Ni-MH – The memory occurrence which appears in that cell types needs full discharging battery before charging process. That discharging process (*Auto* mode) should be done every 5 – 10 charges. One *Format* cycle with *Regen* function will give good effects.

Formatting new packets should be done with 0,2 – 0,3C (3 – 5 *format* cycles)

Regeneration of the packed should be done in 3 – 5 cycles with 0,2 – 0,5C (*Format, Regen - on*).

Li-Ion, Li-Pol – each cell in packets could be parallel (to extend maximal circuits and capacities) and then serial connected to receive suitable voltage. Number of cells set up at charger is equal to the number of serial connected cells. For example for 2P3S packet (2 parallel and 3 serial connections) 3 cells should be set up. Cells (or groups of parallel connected cells) in the time of using could be discharging in various measure. That leads to considerable decreasing of cell capacity. Following discharging/charging cycles increases that occurrence. At the extreme cases this could damage or even auto-ignite the packet. To avoid that danger voltage at every cell should be measured time to time. When the differences in charged batteries are greater than 0.1 V it is recommended to charge each cell separately with maximal 0.5 C circuit and turned off *Fast* mode. It is possible to do 1 – 2 *Format* cycles with active *Regen* mode for each cell separately.

Regeneration of whole packets (*Format, Regen - on*) make sense only when calls are equated. This mode could improve parameters of used packet, but not as that range as regeneration of Ni-Cd packets. For some Li-Ion packets it is advised to charge them to 4,2V each cell. In that case you must charge Li-Ion packets in Li-Pol program.

Li-Ph (Li-Ion FePO₄)

Pulsar EQUAL (communication with Equalizer from Elprog)

A balancer/equalizer balances the cells voltage of Li-Xx packs. A communication between Pulsar EQUAL and Pulsar 2 makes it possible that the charge current will be if needed reduced or cut off. You will find details in the manual from Pulsar EQUAL.

Graf PC software v 2.40

PULSAR charger supports serial port (RS232), which allows you to transmit data. Graf PC is capable of drawing graphs of changes during charging or discharging process. Analysis of voltage, current, voltage time derivative (dV/dt) and temperature curves makes it possible to determine precisely status of batteries and decide whether they need conditioning or not.

Installation

GraphPC is a Windows application. When you start GraphPC for a first time, you will be asked to choose serial port which is used to connect Pulsar Charger (COM 1- 11).

Zooming and Moving the graph – Press left mouse button and drag mouse to right-down direction. Rectangle will be drawn and view inside rectangle will be zoomed after the button is released.

To move the graph move the mouse with pressed right button in needed direction.

Double clicking left mouse button will return to default view.

Data Window - Shows numerical data

After clicking **Data** button window with numerical data will appear (voltage, increase of voltage, current, temperature, time and capacity).

Pressing button with single cell icon, displays the voltage and the increase of voltage count for single cell.



Capacity comparison Window – comparison of battery capacity from several processes.

A column graph allows for quick data comparison, i.e. format or regeneration of packet. Red column shows discharging process (light red to the first change of voltage with *Auto* function)

Green column shows charging process (light green to the inflexion point detection).

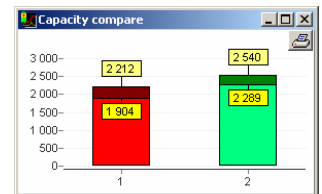

Volt compare Window - comparison of battery voltage from several processes.

When cursor is placed on the voltage line (cursor – cross) and we click left mouse button a value of voltage will be shown in the *Voltage* window.

Pressing button with single cell icon, displays the voltage count for single cell.

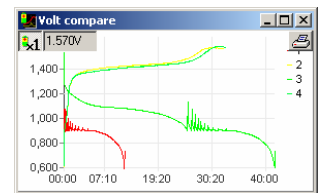

The T i dV Buttons - turn on/off drawing the temperature and increase of voltage curves

Rec Button – Start/Stop data recording

Multisession recording – automatic recording of all data i.e. from the format process.

Save All (File name format - *name#01.acp* – where #01 is a number of the next saved window)

Opening multisession files – automatic opening all data i.e. from the format process.

Opening file saved as *name#01.acp* causes opening all files which the same name with numbers after ‘#’ sign.

Graph description – in each window with graph there is Txt button in upper right corner. After pressing it editor window emerges where data could be inserted:

Producer – name or type of cell

Capacity – packet capacity

User description – graph description

Data will be show after moving mouse over Txt button.

Additional Information

- **Stop of the charging process should be done by pressing the E key for 1s and not by disconnecting the battery.**
- Disconnecting a battery pack during work should be as quick as possible. It is unacceptable to reconnect the battery pack without entering main menu of the charger.
- **Correction of cell quantity should be done always after start of charging process. It is important especially with Li-Ion, Li-Pol, Li-Ph, Li-Ta and Pb-bat cells, when battery is not totally discharged. Overstate cell quantity will damage battery or even in some cases it could cause auto-ignition of the battery.**
- Analysis of Inflexion point and Delta peak starts after 2 minutes for Ni-Cd and 4 minutes for Ni-MH batteries. After that time automatic stop of charging could occur.
- PULSAR charger must be protected from water.
You must not use PULSAR charger during rain – water can get inside and cause severe damage.
- PULSAR charger must be protected from dust.
Built-in fan cools internal radiator and DC/DC converter's coil. Electronic parts can be damaged if there is too much dust in the charger. You must not use PULSAR charger laying directly on a sand, ground or grass.
- The openings in the case must never be covered or sealed.
PULSAR charger works with heavy loads so it becomes heated - it is essential to provide proper ventilation.
- It is not allowed to change supply cables. They are designed to endure currents up to 30A.
- You must supply PULSAR directly from a car accumulator. It is not allowed to supply charger from car lighter socket – this can severely damage car wiring system.
- Make sure all cables connecting a battery pack are at least 2mm in diameter and are not longer than 20cm.
- Charger should be used under supervision. Li-Xx batteries should be charged in fire resistant container and under permanent supervision. We recommend the **Pulsar EQUAL** which is optimized for using with **Pulsar 2**.
- Shortly before the end of charging process of Ni-Cd or Ni-MH accu Pulsar inform us using short beep about achieving of Inflex point. The same beep, during Li-Xx charging in normal mode, inform us about start of current reduction process, or about beginning of the last phase of charging in Fast mode.

Examples Setting process parameters – memory 1 – 8

- **Setting up current**
 - E - current value is blinking
 - + or - - set up needed current value
 - E - confirm and return to menu or set up current (in complex processes)
- **Setting up working mode and cell types**
 - M (1s) - name of working mode is blinking (*Disch.*; *Charge*; *Dis/Ch*; *Ch/Dis*)
 - + or - - set up working mode
 - E or M - confirm, type of cell is blinking
 - + or - - set up proper cell type
 - E or M - confirm and return to menu
- **Setting up additional parameters – charging NiCd or MiMh cells**
 - E (1s) - the *On/Off* is blinking for *inflex* mode (decreasing heat of the packet)
 - + or - - set up working mode
 - E or M - the *On/Off* is blinking for *Reflex* mode (charging with equalizing impulse)
 - + or - - set up working mode
 - E or M - the *d/D* is blinking for *Delta* parameter (d – more sensitive Delta Peak threshold)
 - + or - - set up working mode
 - E or M - confirm and return to menu

Pulsar 2 – first steps

Pulsar 2 is a professional device which need a proper handling. This information is provided to guide through first steps, help to achieve routine in handling faster and prevent from beginning difficulties.

Basics sets-up

After turning on, Pulsar 2 displays first menu, in which we can set basic functions, which are common for all process. To set them we have to press M key. Instead, pressing E key moves us directly to next level. Parameter, which is blinking can be adjusted by pressing +/- keys.

1. Turn on charger (battery not connected)
2. Press M (setup)
3. Bib on/off (acoustic signal on/off) choose required option using keys +/-
4. Press E
5. T max (temperature control on/off) choose required option using keys +/-
6. Press E
7. T on < (start temperature – after the battery will be cooled to this temperature process will be activated) choose required option using keys +/- (in range 30-45°C only if T max is -on!)
8. Press E
9. T off > (in this temperature process will be terminated) choose required option using keys +/- (in range 50-65°C only if T max is - on!)
10. Press E
11. V off – set of minimal supply battery voltage (protection from deep discharge)
12. Press E key to end setting

After complete this steps, we are again in main menu.

Adjust the process settings

In this example we will set process of charging battery Ni-Cd.

1. Turn on the charger (battery not connected)
2. Press M (start)
3. +/- choose position (number) in memory in which we want to save process options
4. Press and hold M (over 1s) move to settings
5. +/- choose required process – in this example “Charge” charging
6. Press M
7. +/- choose required type of batteries (in this example Ni-Cd)
8. Press M

At this step we are in programmed process memory and if we don't want to change parameters, we can connect battery and start charging.

However, if we want to adjust or just check parameters:

9. Press and hold E (over 1s)
10. Inflex on/off
11. Press E
12. Reflex on/off
13. Press E
14. Delta low/high (Delta Peak - choose required value), low – higher sensitivity so charging will end earlier
15. Press E

Now we are again in set memory with properly adjusted parameters. Before we will start charging we can correct charging current value:

16. Press E
17. +/- set required charging current
18. if necessary set cells capacity* (press **M** and with +/- set the demanded value, "--,-" - capacity control disabled)
19. Press E

Up to this moment we passed through all possibilities of setting up a process. Analogical, we can set up every other process (for example discharge). Serial processes (for example discharging/charging) are set individually, that means we can set different parameters for discharge and charge. For example we are able to discharge and charge using different currents.

Here we are pointing for basic rule! By key **M** we are setting "WHAT" and by key **E** "HOW". Short (under 1s) pressing **M** opens information window (access to memory of 8 latest processes) and **E** – sets up current.

*) Capacity setting of battery can be applied as a "limiter". This function is really useful when we want for example prepare battery for longer storage. Then we can charge previously discharged battery up to for example 10% its capacity. When process will reach properly set capacity (for example 240 mAh with 2400mAh battery) process will be automatically stopped.

Capacity setting can be also applied as an additional control of charged energy. In this purpose we recommend to set capacity to about 10-15% more than battery has. Other way the battery may not be fully charged. **Caution** – this function is important when we are charging new or long stored cells Ni-Cd and Ni-MH.

Charging

1. Turn on charger (battery not connected)
2. Press E (start)
3. Choose the right number of memory (or program process – described above)
4. Connect battery and if necessary +/- correct number of cells (**Caution!!!** – correct setting decide of using safety!!!)
5. Press E (start) – process initiated

Forced start

Packets, which are built in various devices (transmitters, servo programmers etc.) are often secured from improper poles connection with built-in diode. If we connect secured device (i.e. transmitter) to the charger, it won't be able to measure the voltage of cells or detect quantity of them. To charge batteries in this situation we must start charging process manually. To do this Reflex function must be disabled (the discharging pulses would be blocked by diode). After choosing suitable process we connect device to charger and then press the +/- buttons simultaneously. Then the quantity of cells must be set manually and charging process started by pressing **E** key. **Caution** – battery voltage will be displayed with the 0,6 V voltage drop caused by diode added !

We recommend to short switching that kind of diode wherever it is possible (i.e. in Graupner's transmitters with proper jumper). Pulsar 2 is secured from improper poles connection and can not damage the transmitter. The advantage of this solution is access to all Pulsar 2 functions (reflex, discharge, etc.). **Caution** – we recommend to pay attention to acceptable maximal charging current (i.e. Graupner's transmitters: 1 – 1,2 A).

Symbols used by Pulsar 2

1. --,-mAh - control of battery capacity is inactive
2. --,- C - control of temperature is inactive (sensor not connected)
3. ↑ - increase voltage pointer
4. ↓ - voltage drop pointer
5. 1 ... 8 – memory number
6. A – while discharging – “Auto” function on
7. **A** (bold) – reduction current by charger pointer (maximal charger power was achieved/passed)
8. C1 ... C8 – format – number of remaining charge processes during formatting battery
9. d – Delta low set
10. D – Delta high set
11. E – blinking – current reduction active (in the end of process)
12. i – inflex function on
13. i – blinking – detection of inflex point (when inflex is not activated, Pulsar is still charging until detection of Delta peak)
14. r – Reflex function active
15. R – Reverse function active (return energy)
16. S – blinking – begin of charging process signalization – current gradually increase
17. v – off voltage limit active (only with Li-xx)

Recommended settings

1. **Inflex** - with Ni-Cd and Ni-MH only when charging current is higher than 1C. When we want to charge package of batteries to maximum, we should turn on inflex function.
2. **Reflex** – it’s always good when on
3. Function “auto” (while discharging) extend time of discharging, but discharge battery completely. If we care about time we can turn this function off.
4. **Delta high/low** – with “low” charging process is terminated faster than with “high”. When battery has to be maximally charged we can use switching off in “high” mode
5. Package temperature – many modelers prefer to have “warm” package to fly, drive or sail. Pulsar 2 is generally set for possible economical use of battery, which lead to small increase of temperature during charging. So we can increase (experimentally) charging current to get demanded package temperature.
6. **Fast** with Li-xx. Saving time is considerable by charging with currents over 1C. Please obey battery producer recommendations. This function can be used with a special balancer (eg. Pulsar EQUAL from Elprog).
7. **Format** – the best is to use small current but not lower than 0,1C but also not higher than 1C and in 4 – 8 cycles. When we have older battery to regenerate them 0,5 – 1C and the best with regeneration function enabled. In this case 4 – 5 cycles are enough. It’s good to charge battery to 20 – 25% of his capacity before we start to format or regenerate it. In this modes it’s good to use “limiter” function (set maximal capacity to 10 –15% higher then battery maximal capacity)
8. During current setting we ask you to pay attention on maximal times of processes. When charging/discharging Ni-Cd and Ni-MH 5 hours. When charging Li-xx 14 hours. One cycle when formatting maximal 2 x 14 Std. Always adapt current setting to those times.
9. **Caution** – always pay attention that number of cells setting is correct!!!. Li-Xx cells should be charged under permanent supervision and on inflammable surface.

Alarms

Tc = 50,0	-	exceed(overflow) of set temperature (blinking “Tc=”)
Vb = 16,0V high	-	to high supply voltage (blinking “high”)
Vb = 10,5V low	-	to low supply voltage (blinking “low”)
VC = high	-	battery voltage exceeded. Incorrect number of cells set, damaged battery or to high charging current set

Warranty

ELPROG guarantees this product against defective components and faulty workmanship for a period of 24 months. Any defect in materials or workmanship occurring within 24 months from the date of purchase subject to the following conditions will be rectified free of charge by ELPROG within 14 working days.

Conditions

1. This guarantee must have been completed at time of purchase (this is your proof of the date of purchase).
2. The guarantee applies only to faults caused by defective components, or faulty workmanship on the part of the manufacturer.
3. The guarantee does not cover failures caused by accident, misuse, neglect, normal wear and tear, alternations and/or adjustment made to the charger.

ELPROG
ul. Przemysłowa 1/611
PL 35-105 Rzeszów



Sales, distribution and service:

pp-rc Modellbau Piechowski
Weidenstieg2
25337 Köln-Reisiek
GERMANY
WEEE-Reg.-Nr DE77074747
Tel.: +49 4121 740486
Fax: +49 4121 750676
www.pp-rc.de

Notes:

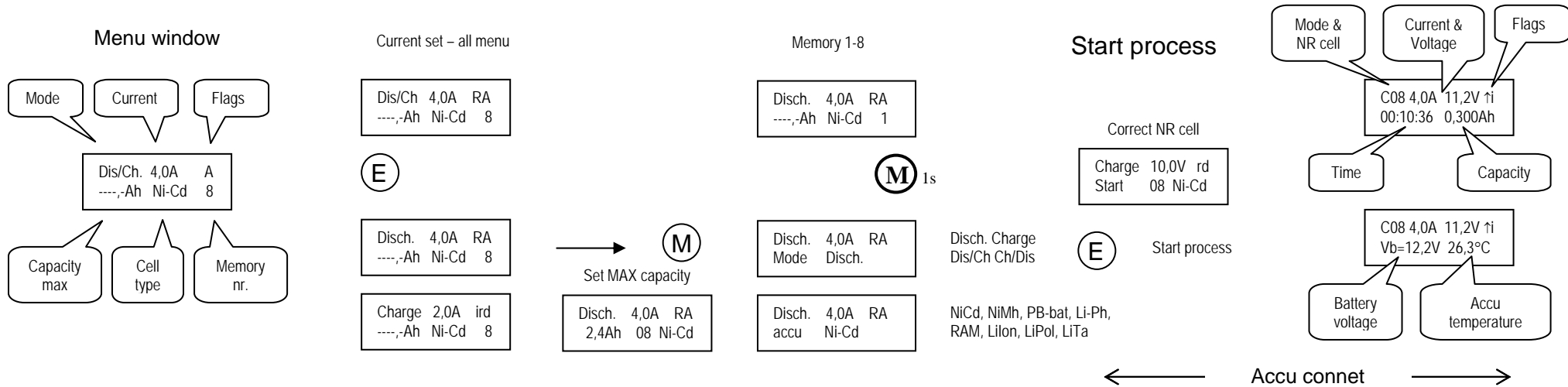

Pulsar 2v15

