

PULSAR-EQUAL v 1.09

Art.No.: 6910



The **Pulsar-EQUAL** is a professionally designed and built, micro processor controlled balancer/equalizer and tester. The **Pulsar-EQUAL** is able to equalize the voltage of single cells in an accupack in a very short time. All types of Lithium-Accus from 2 to 12 cells can be equalized. Because of the very high continuous performance even high capacity cells can be handled in a minimum amount of time.

The development of the **Pulsar-EQUAL** concentrated on offering most complete and precise information of each cell in an accupack. The display informs in detail about all operations in real-time and the voltage of all cells is visible at all times. The entire processing can be captured by a PC and allows interpretation and comparison at a later point in time.

In order to keep the charging time to the minimum, the **Pulsar-EQUAL** offers a very high equalizing performance of 45 W with a maximum equalizing current of 4 A, limited to 0.75 A per single cell. The **Pulsar-EQUAL** controls all charging parameters of the cells and is able to communicate with chargers like the **Pulsar 2** or **Akkumatik** to reduce the charge or discharge current, if required. The **Pulsar-EQUAL** will even initiate an emergency shut down of the charging process, if the positive charging leads are connected to it.

During the equalizing process, the cells with the highest voltage in the accupack deliver the energy for the cells with the lowest voltage. This principle increases the overall efficiency and reduces the load on the power supply, e.g. a starter battery.

Technical Data	
Type of Accus	Li-Ion, Li-Po, Li-Ph (<i>Li-Ion FePO₄</i>)
Max. Equalizing Performance	45 W
Max. Equalizing Current per Cell	0,25 A; 0,5 A; 0,75 A (continuous)
Min. Equalizing Current per Cell	25 mA; 50 mA ;75 mA (continuous)
Max. Operating Current of Pulsar-EQUAL	Up to 1,2 A
No. Of Cells equalized simultaneously	1 to 11 (12 Channels)
Modes of Operation	Test, Equal, Fast
Operating Voltage	6 to 60 V
Quiescent Current	At 2 cells: 18 mA; at 12 cells: 10 mA
Timer	2 h; 4 h; unlimited
Displaytype/Size	LCD / 133x64 mm
Emergency shut down at	75 V; 15 A
Air Cooler	Temperature regulated
Dimensions ca.	120 x 110 x 34 mm
Weight abt.	300 g

Warnings

- READ THE INSTRUCTION MANUAL BEFORE THE FIRST USE OF THE **PULSAR-EQUAL**
- Never make any changes to the **Pulsar-EQUAL**, internally or externally
- Always check the correct polarity
- Avoid any moisture or dust
- Avoid any short circuits
- Do not cover the cooling fan case opening or stick anything into it
- If you detect any irregularities during operation, stop the process immediately and call the service line.
- Never leave the **Pulsar-EQUAL** unattended

EG-Conformity

We herewith declare the conformity of the **Pulsar-EQUAL** with EN 55014-1:2000+A1:2001+A2:2002 und EN 55014-2:1997+A1:2001 (Cat.II)

The **Pulsar-EQUAL** is labelled with:



Dispose of **Pulsar-EQUAL** according to your countries regulations.



Producer:

ELPROG
ul. Przemysłowa 1/611
PL 35-105 Rzeszów

General Distribution:

pp-rc Modellbau Piechowski
Weidenstieg2
25337 Kölln-Reisiek
GERMANY

Tel.: +49 4121 740486 Fax: +49 4121 750676 www.pp-rc.de

WEEE-Reg.-Nr DE77074747

Introduction

Lithium-Accus are to be charged with the CC/CV (Constant Current/Constant Voltage) process. A specific charge cut off voltage per cell should not be exceeded. For lithium-polymere cells this charge cut off voltage is 4.2 V. Charging above this voltage will damage the cell and may result in total destruction with the danger of fire or even explosion.

When using li-po-accupacks, the voltage of the cells in an accupack tend to drift. This can lead to dangerous voltage differences between the cells in an accupack.

***Example:** If you want to charge a 5S-Li-Po-Accupack, the charger will charge the pack to the charge cut-off voltage of 21V. (5 x 4.2 V). Assume 4 of the cells have a voltage of 4,1 V then the charger would end the charging process when the fifth cell has a voltage of 4.6 V. Overcharging this cell is dangerous and may cause a fire. A balancer will avoid this and protect your accupack.*

Balancer and Equalizer differ in the way they operate. A balancer can only equalize the cells during charging. Once a cell reaches the charge cut-off voltage, charging of this cells is terminated by diverting the charge current into resistors, converting the energy into heat.(like a Voltage Limiter) An equalizer is able to equalize the voltage of cells in an accupack without the charging process. Up to date equalizers transfer the energy of the cells with the highest voltage to the cells with the lowest voltage in the accupack. This principle is adopted by the **Pulsar-EQUAL**. Balancing/Equalizing only makes sense at a certain voltage level. The **Pulsar-EQUAL** will start equalizing at a voltage of 3.8 V per cell and will apply its full performance once the cell has reached a voltage of 4.0 V.

It should be mentioned, that equalizing of the cells in an accupack is not required at each charge. You will learn from experience, how your accupacks perform regarding voltage drifting of the cells and you will know, when to equalize the accupack.

However, we suggest to use the **Pulsar-EQUAL** at all times, to play it safe and always have full control over your expensive lithium accupacks.

Connection and Control Elements

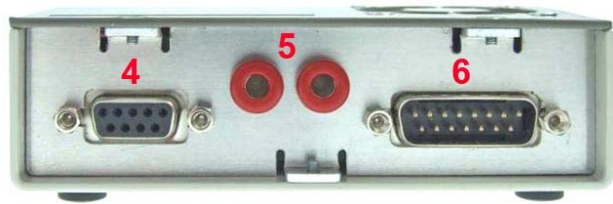

1. Display
2. Control button
3. Air cooler
4. RS 232 (connecting cable comes with the kit)
5. Sockets for charge leads (shut down function)
6. Socket to connect the accupack

Device Connection

Accupack

Connect your accupack (2 to 12 cells) with the *Pulsar-EQUAL* via the 15 pole plug. Please mind the polarity and pin connections. False connections may result in damaging the *Pulsar-EQUAL* or your accupack. The proper connection of pins and cells in an accupack is shown below (refer to left drawing).

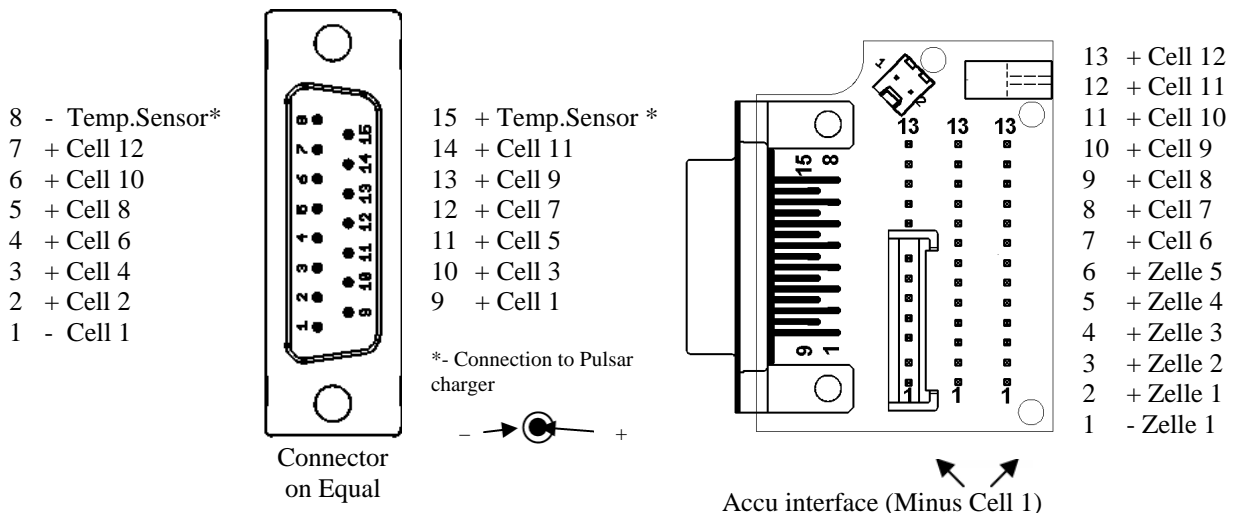

We recommend to use our accu interface, providing a communication cable to the *Pulsar 2* charger and a connection socket for the temperature sensor. The accu interface also allows to install the most popular balancer plugs in use today (for details, refer to the drawing at top right). If you are planning on your own balancer system, keep in mind, that pins 8 and 15 can be used to establish a connection to the *Pulsar 2* via the temperature sensor socket. In mounting a parallel temp socket to these pins, the temperature sensor will stay operational. Required plugs, sockets and cable are available from your local electronic parts shop.

Charger

As usual, you select the desired charge parameters at the charger. Next, you connect the positive charge lead of the charger to one of the red connection sockets of the *Pulsar-EQUAL*. At the other red socket you connect another charging lead to connect the accupack. Now you connect the communication cable to the temp sensor socket of the *Pulsar 2*. Following you connect the negative charging lead to the charger and the accupack.. After this, you connect the balancer cable to the *Pulsar-EQUAL*. You are now ready to select the *Pulsar-EQUAL* parameters and to start the process.

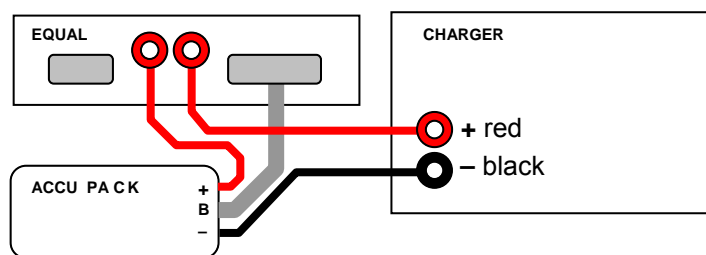

Settings and Operation

General

The *Pulsar-EQUAL* is operated with only one control button. The *Pulsar-EQUAL* differentiates between pushing the button short (less than 1 second) and long (more than 3 seconds). A short push will verify a choice or change the operating parameters. A long push of the button will start the menu. Connecting an accupack to the *Pulsar-EQUAL* is acknowledged by a short “beep”. Pushing the button once shortly will start the operation of the *Pulsar-EQUAL*, using the settings of the former process. In order to change the parameters you need to push the control button for more than 3 seconds:

Memory sets

After entering into configuration mode actually chosen memory set (**1**, **2** or **3**) is flashing for ab. 3 seconds. Each set can store different settings of: work mode, power settings, sleep or accu type. It makes settings faster when working with different accu types. When the program number is flashing, a brief button push will switch memory set to the next (looped 1-2, 2-3, 3-1). If nothing is to be changed, just press a button for a longer time period – this is exit from configuration mode. However, if you want to change parameters, wait ab. 3 seconds. After that time period Pulsar-EQUAL will enter the mode of work mode change. A memory cell change clears all former alerts.

Work mode

Actual work mode is flashing. You can change work mode (in a loop) just by brief button push. Work modes are: Equal, Fast, Test.

Equal this is the standard mode of operation. The voltage of the cells in an accupack are equalized during charging/discharging or without a charger connected. Please keep in mind, that below the start voltage for balancing (refer to table Cell Types) no equalizing will be carried out.

Fast this special operation mode has been developed for charging in the Fast-mode of the Pulsar 2 charger.

Test in this mode, all cell parameters will be displayed on the display or can be recorded on your PC. EQUALIZING WILL NOT TAKE PLACE. No charger needs to be connected in this mode. With the test mode the behaviour of an accupack can be recorded, simulating the actual loads on the accupack during its use in the model.

Following the selection of the mode of operation please wait 3 seconds and the *Pulsar-EQUAL* will automatically switch to the settings of the performance levels.

Setting the Performance Level

The *Pulsar-EQUAL* offers an outstanding equalizing performance which is well above those of other comparable balancers/equalizers. The *Pulsar-EQUAL* is perfectly suited for new and coming cell technologies with even higher capacities and charge rates.

For cells with smaller capacities this performance may be too high. In this part of the menu you can therefore reduce the performance to adapt the equalizing power to those smaller cell capacities.

Available are three levels of performance:

I = 0,25; I = 0,5; I = 0,75

These values represent the maximum continuous equalizing current per cell in Amperes. For charging cells up to a capacity of 2000 mAh with a charge current of 1.5 C, the lowest performance level of I = 0.25 is sufficient. When charging cells with higher capacities or charging in fast mode, the level can be increased. The *Pulsar-EQUAL* is able to equalize cells in accupacks with a capacity from 100 mAh to over 10 Ah.

Sleep

Once having set the performance level you can now limit the maximum operating time. Selecting “0H” disables this function. Selecting „2H“ and „4H“ you set the maximum operating time to 2 hours and 4 hours respectively. When approaching the maximum operating time the *Pulsar-EQUAL* interrupts the charging via the positive charging leads and terminates any equalizing.

A sleep termination is indicated on the display with a flashing “sleep” instead of the performance level. Nevertheless, change of the settings is always possible, even after a sleep termination has occurred.

Type of Accupack

The last item on the menu is the setting of the accu type. Following settings are available right now:
Li-Po (Lithium-Polymer); Li-Ion (Lithium-Ionen); Li-Ph (Lithium-FePO₄)

Display contrast adjustment

Push the button until 2 beep heard (after the first one, display goes blank). Short pressing of the button after that will increase display's contrast to the desired level (20 step loop). After desired contrast level is achieved, leave the button for 6s to store your adjustment.

Process Control – Display Elements

Having started the equalizing process, you can switch between three display modes by pushing the control button shortly:

1. Number of memory
2. Battery load indicato
3. Battery load in % *
4. Voltage of accupack
5. Work mode
6. Maximal equalizing current (for single channel)
7. Sleep timer after 0 (switched off), 2 or 4h
8. Cell type (Li-Pol, Li-Ion, Li-Ph)
9. Voltage of accupack, divided by No. of cells
10. Highest cell voltage in the accupack
11. Difference between the cell with the highest and the lowest voltage in the accupack
12. Lowest cell voltage in the accupack
13. Moment performance level
14. Number of cells in the accupack
15. Line, indicating +0,05 V above average
16. Average voltage and voltages differences of all cells displayed as bar chart
17. Line, indicating -0,05 V below average
18. Equalizing level, represents the equalizing current
19. Bartery pack charge (%) *
20. Time scale line (10/5 min)
21. Voltage curve
22. Line, indicating the charge cut off voltage
23. Line, indicating the discharge cut off voltage
24. Time scale (10 min/5 min)
25. Voltage of each cell in the accupack. The cell with the highest and lowest voltage is indicated with arrows up and down. (here the cells No. 1 and 12)
26. Column graph - shows charge of each, single cell during equalizing of battery pack.
27. Max charge (Ah) of a weakest cell - adequate to 100% of the column graph p.19 (highest column)

* - estimated value (different packs can show different numbers)

Graphics

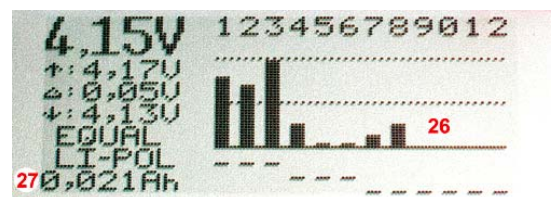
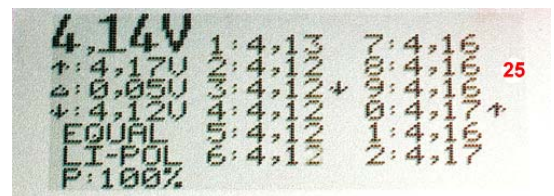
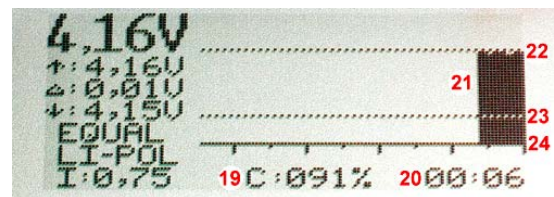
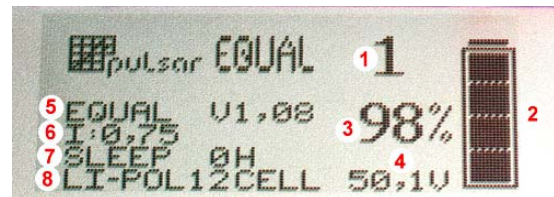

More Important Information on the Processing

- In Fast mode the **Pulsar-EQUAL** will start equalizing at a voltage difference of 20 mV or greater. Equalizing will stop at a voltage difference of 10 mV or less. In Equal mode the values are 10 mV and 5 mV.
- In case of extreme voltage differences within the cells of an accupack, the **Pulsar-EQUAL** may even start an equalizing process below the balancing start voltage. This algorithm is based on a Fuzzy-Logic-approach.

Cell Type Parameters

Name	Li-Ion	LiPo	LiPh
Name	Lithium-Ionen	Lithium-Polymer	Lithium-FePO ₄
Nominal Voltage	3,60 V	3,70 V	3,30 V
Discharge Cut Off Voltage	3,00 V	3,30 V	2,80 V
max. Charge Cut Off Voltage	4,10 V	4,20 V	3,65 V
Voltage causing current reduction	4,15 V	4,25 V	3,80 V
max. Emergency Shut Off Voltage	4,25 V	4,35 V	4,10 V
min. Emergency Shut Off Voltage	2,50 V	2,70 V	2,00 V
Voltage to start equalizing	3,85 V	3,95 V	3,48 V

Emergency Shut Off

If one cell in the accupack exceeds the max. or min. emergency shut off voltage, the *Pulsar-EQUAL* indicates this with an acoustic alarm signal.

A sound alert is started whenever a switch off voltage value is reached (see: Cells). In the same time accu pack will be disconnected from charger (if it was connected to the charger via balancer's switching socket – a two, red connectors). This sound alert can be switched off by button push. An average voltage value (graphics p.1) and number of the cell which caused this alert will be flashing on the display (Graphics p.8 or p.18).

Connecting of balancer to Pulsar 2 (starting from v.2.10) or Pulsar 2+

Whichever cell reach voltage of current reduction (see: Cells), a charger will decrease charging current until cell voltage fall under that value. If a sound alert is being generated, but accu pack isn't connected via balancer's switching socket, charger will decrease charging current. A number of the cell which caused this charging current decrease will be flashing on the display (Graphics p.8 or p.18)

Firmware-Upgrade

The *Pulsar-EQUAL* is ready for a simple Firmware-Upgrade with your PC. First download the software (exe-File) to you PC-hard drive. The *Pulsar-EQUAL* must be connected to your PC at a COM-Port and the *Pulsar-EQUAL* needs to be connected to an accupack via the balancer connector. The control button should not be pushed after switching on the *Pulsar-EQUAL*. As soon as the connection is being established, the exe file can be executed. In order to prevent problems during the upgrade, close all other programs in advance and make sure to select the right Com-Port (COM 1 to 11).

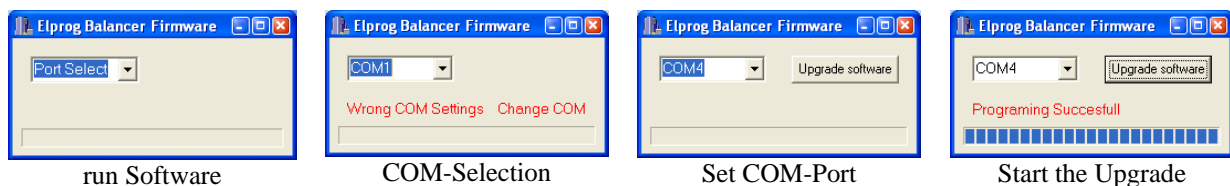

Interrupting the Upgrade may lead to damage of the *Pulsar-EQUAL*.

PC

The *Pulsar-EQUAL* may be connected to a PC using one of its COM-Ports Thus data is transferred to the PC for real time analysis. In case your PC or Laptop does not have a Com-Port, simply use any USB>COM-adapter.

PC-Software (Pulsar-EQUAL v 1.08)

The *Pulsar-EQUAL* comes with a Software CD. The RS-232-Port is located at the back side of the *Pulsar-EQUAL* housing enable ling communication between the *Pulsar-EQUAL* and your PC. This is a helpful feature to analyse the state of cells in an accupack.

Installation

The software provided is compatible to Windows Operating Systems 95, 98, ME, 2000, XP, and Vista. The installation is self explanatory and only requires the right COM-Port, to which the *Pulsar-EQUAL* will be connected.(COM 1 to 11).

Attention: In case your PC or Notebook does not have a COM-Port, you may use any USD>COM-Adapter, to connect the *Pulsar-EQUAL*.

Equal Data Window

This window displays the data in form of real time numbers. (Voltage, Equalizing Performance (%), Process time, min/max Voltage, delta-Voltage, Number of Cells, cell type, mode of Operation and Voltage for all cells). Clicking on the single cell symbol in the upper left corner (x1), the voltage will be displayed calculated for one cell.



Bar Chart Window

The green bars show the voltage differences of single cells versus the average voltage per cell of the accupack. The numbers below or above the bars tell the difference in mV.

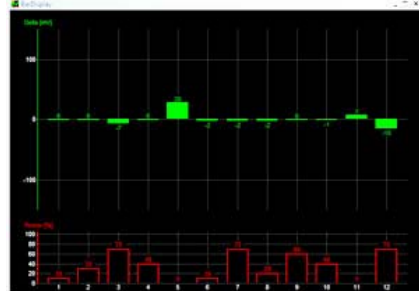

By clicking "Ah" button (on the main window) you can display charge (Ah) of each cells during equalizing of battery pack. Value "Ah" corresponds to the highest column and is adequate to 100%. Columns are scaled in %.

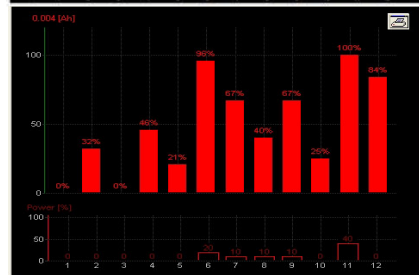

The red bars at the bottom inform about the equalizing performance of each channel.

Average Window

In selecting the average symbol on the task bar allows you to switch between two display modes.

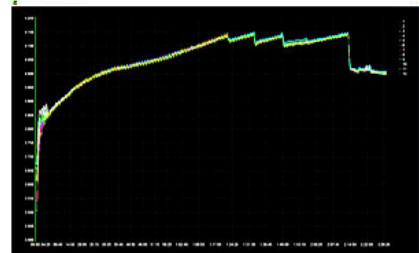

The first display mode shows the voltage of each cell during charging/equalizing in differently colored curves. A mouse click on one of the curves results in a bold display of this curve.

The second display mode offers the following information:
The green bold curve represents the average voltage (avr V).
The yellow curve represents the cell with the highest voltage (max V) and the orange curve represents the cell with the lowest voltage (min V)
The blue curve at the bottom represents the voltage differences between the cells in the accupack (Delta)

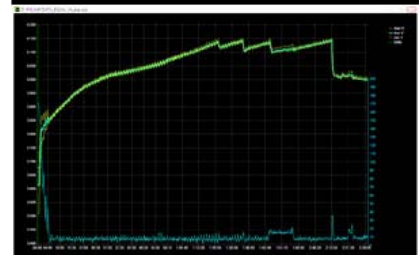

Zoom and Scroll

With your left mouse button you can zoom into a fraction of the curves. A double click gets you back to the original window (unzoom). With your right mouse button you can scroll to the right and left in the zoomed Window.

Button Rec

Clicking on the „REC“ symbol will start or stop the data recording on your PC.

Remarks

You might experience, that the charge/discharge curves displayed at your PC are not smooth, but will show voltage drops. This will occur, whenever you use a charger with impulse charge mode. These chargers, like the *Pulsar 2* and the *Pulsar-EQUAL*, measure the cell voltage in charging/equalizing breaks. Synchronizing these breaks would require extensive software development and was therefore not realized. The accuracy of the voltage curves is not affected by this.
